

## SMD- Full Color Side View LEDs C4506FDWN301-GRBD01302017-2G

**Preliminary**

This is a preliminary specification intended for design purposes and subject to change without prior notice.

### Features

- P-LCC-8 package.
- Inner reflector and white package.
- Built in 3 LED chips.
- Colorless clear resin
- Wide viewing angle 120°.
- White SMT package.
- Soldering methods: IR reflow soldering.
- Pb-free.
- The product itself will remain within RoHS compliant version.
- Compliance with EU REACH.
- Compliance Halogen Free .(Br <900 ppm ,Cl <900 ppm , Br+Cl < 1500 ppm).
- Precondition: Bases on JEDEC J-STD 020D Level 3

### Applications

- Switches, symbol, mobile phone, digital camera and illuminated advertising.
- Display for indoor and outdoor application.
- Substitution of traditional light.
- Amusement equipment.
- General applications.
- Optical indicator.

**Absolute Maximum Ratings (Ta=25°C)**

Parameter	Symbol	Type	Rating	Unit
Forward Current	I <sub>F</sub>	G	30	mA
		R	30	
		B	30	
Peak Forward Current (Duty 1/10 @1KHz)	I <sub>FP</sub>	G	60	mA
		R	60	
		B	60	
Power Dissipation	P <sub>d</sub>	G	100	mW
		R	75	
		B	95	
Operating Temperature	T <sub>opr</sub>		-40 ~ +85	°C
Storage Temperature	T <sub>stg</sub>		-40 ~ +90	°C
Soldering Temperature	T <sub>sol</sub>		Reflow Soldering : 260 °C for 10 sec. Hand Soldering : 350 °C for 3 sec.	

EVERLIGHT  
 Preliminary

Electro-Optical Characteristics (Ta=25°C)

Parameter	Symbol	Type	Min.	Typ.	Max.	Unit	Condition
Luminous Intensity	Iv	G	1600	2725	4045	mcd	
		R	635	1075	1680		
		B	225	375	615		
Viewing Angle	2θ <sub>1/2</sub>		-----	120	-----	deg	
Dominant Wavelength	λd	G	520	---	535	nm	G:I <sub>F</sub> =30mA R:I <sub>F</sub> =20mA B:I <sub>F</sub> =17mA
		R	618	---	628		
		B	462	---	472		
Forward Voltage	V <sub>F</sub>	G	2.7	3.1	3.4	V	
		R	1.8	2.05	2.5		
		B	2.45	2.8	3.15		
Reverse Current	I <sub>R</sub>	R	-----	-----	10	μA	V <sub>R</sub> =5V
		G	-----	-----	10		
		B	-----	-----	10		

Notes:

1. Tolerance of Luminous Intensity: ±11%
2. Tolerance of Dominant Wavelength: ±1nm
3. Tolerance of Forward Voltage: ±0.1V
4. LED components are not supposed to be reverse operated.

### Bin Range of Luminous Intensity

Bin Code	Min.	Max.	Unit	Condition
X1	2900	3920	mcd	G:I <sub>F</sub> =30mA
X2	3920	5300		R:I <sub>F</sub> =20mA B:I <sub>F</sub> =17mA

Note:  
Tolerance of Luminous Intensity: ±11%

### Chromaticity Coordinates Specifications for Bin Grading

Color Bin Table (G:I <sub>F</sub> =30mA,R:I <sub>F</sub> =20mA,B:I <sub>F</sub> =17mA)											
Bin Code	Color Bin Limits					Bin Code	Color Bin Limits				
	CIE	Point1	Point2	Point3	Point4		CIE	Point1	Point2	Point3	Point4
J3	x	0.2598	0.2823	0.2823	0.2598	K3	x	0.2823	0.3048	0.3048	0.2823
	y	0.2937	0.3012	0.3237	0.3162		y	0.3012	0.3087	0.3312	0.3237
J4	x	0.2598	0.2823	0.2823	0.2598	K4	x	0.2823	0.3048	0.3048	0.2823
	y	0.3162	0.3237	0.3462	0.3387		y	0.3237	0.3312	0.3537	0.3462

### The C.I.E. 1931 Chromaticity Diagram

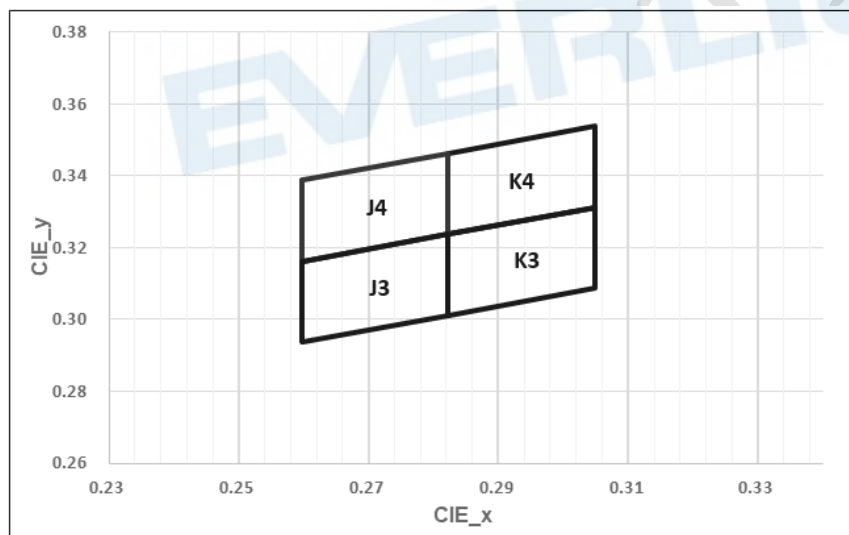

Package Dimension

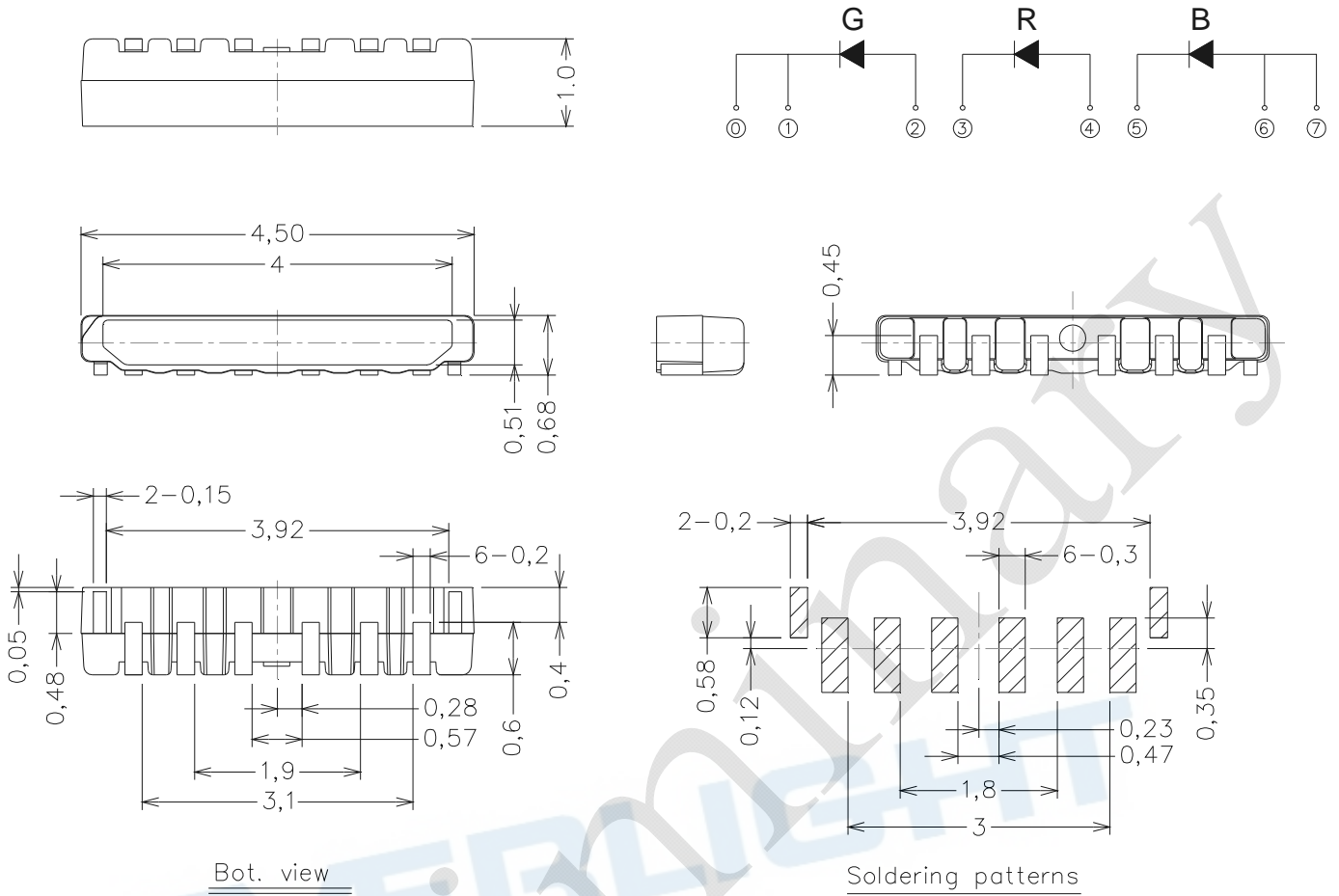

Suggested pad dimension is just reference only.  
 Please modify the pad dimension based on individual need.

Note: Tolerances unless mentioned  $\pm 0.1$ mm. Unit = mm

## Typical Electro-Optical Characteristics Curves

### Typical Curve of Spectral Distribution

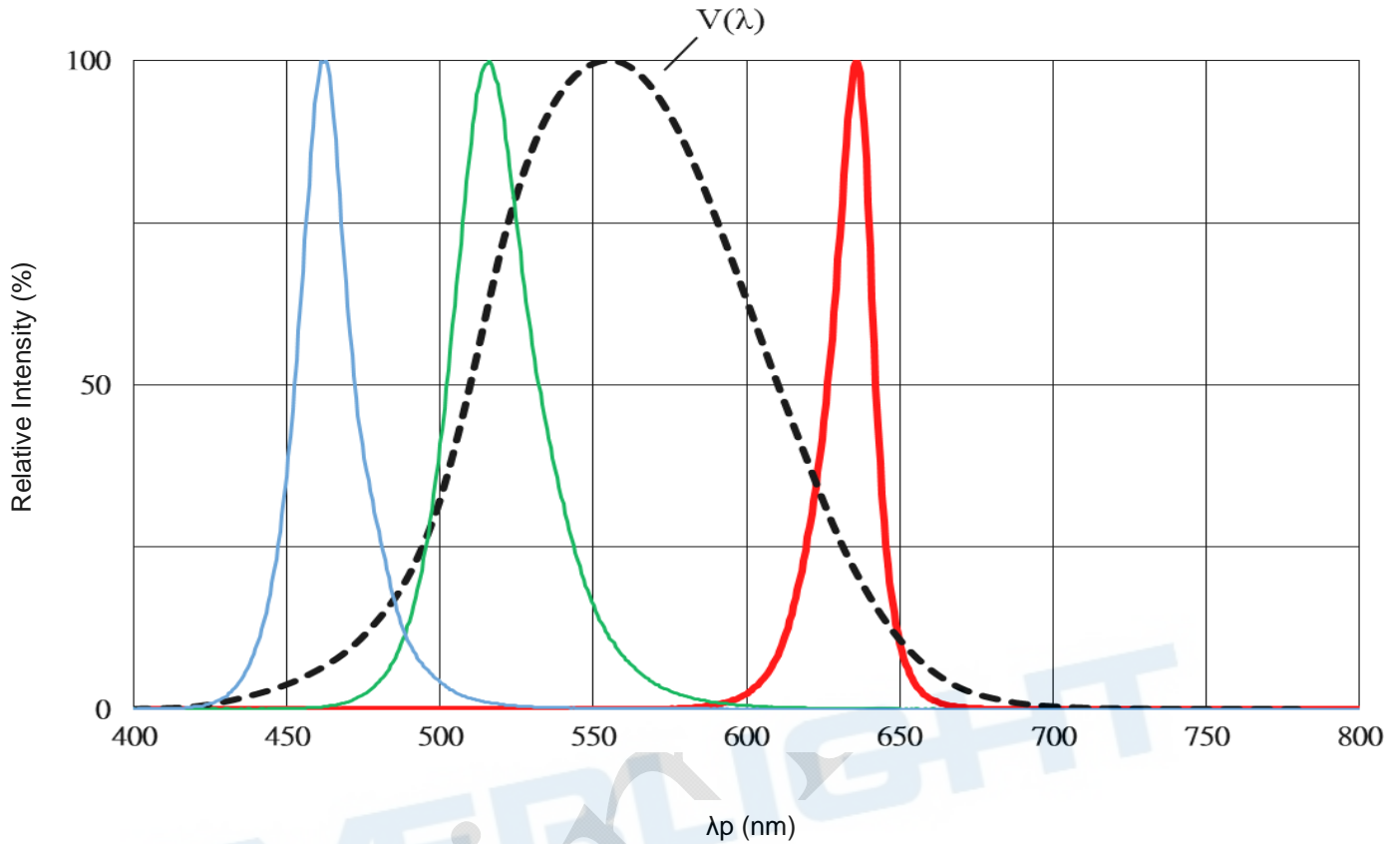

Note:  $V(\lambda)$ =Standard eye response curve; R:If=20mA, G:If=25mA, B:If=15mA

### Diagram Characteristics of Radiation

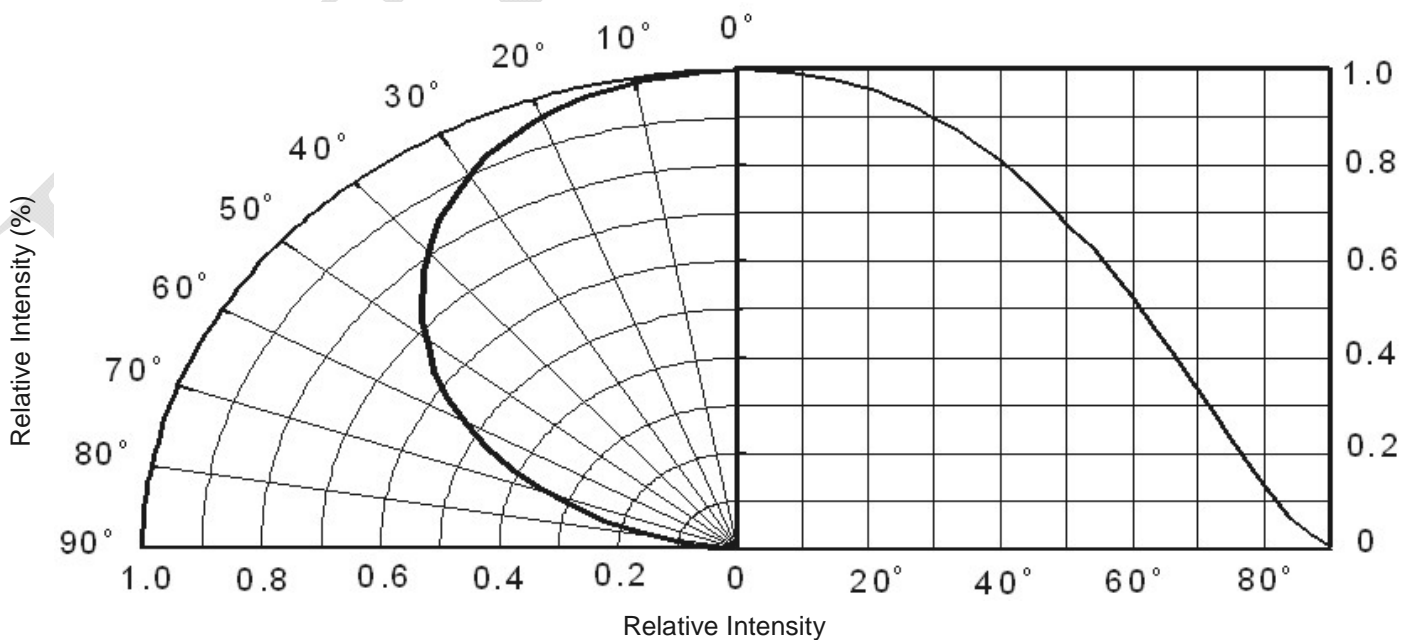

Forward Current vs. Forward Voltage (Ta=25°C)

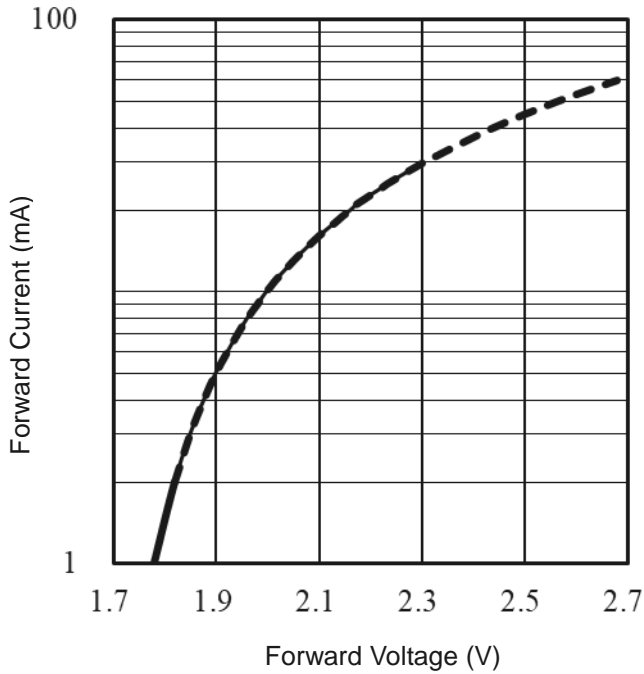

Dominant Wavelength vs. Forward Current (Ta=25°C)

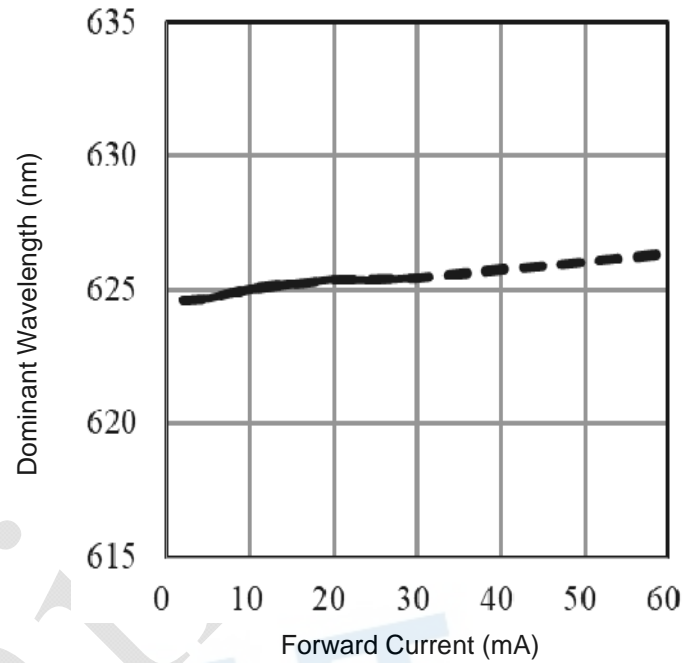

Relative Luminous Intensity vs. Forward Current (Ta=25°C)

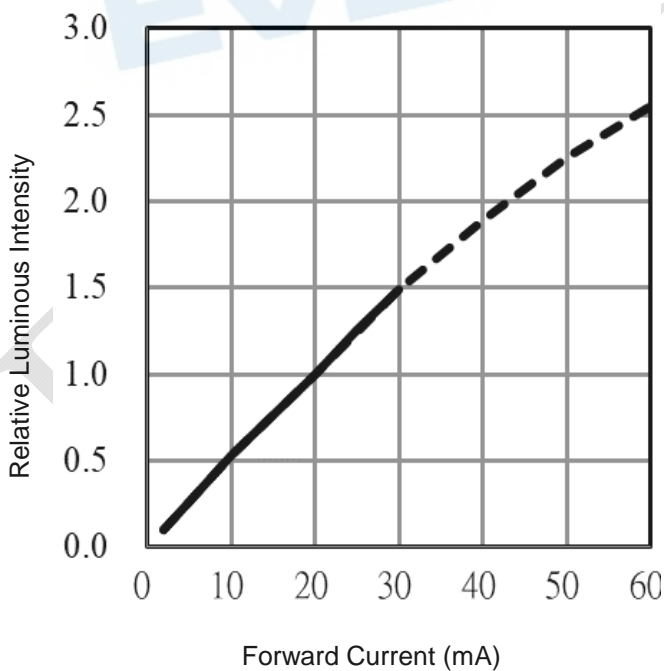

Max. Permissible Forwarded Current (Ta=25°C)

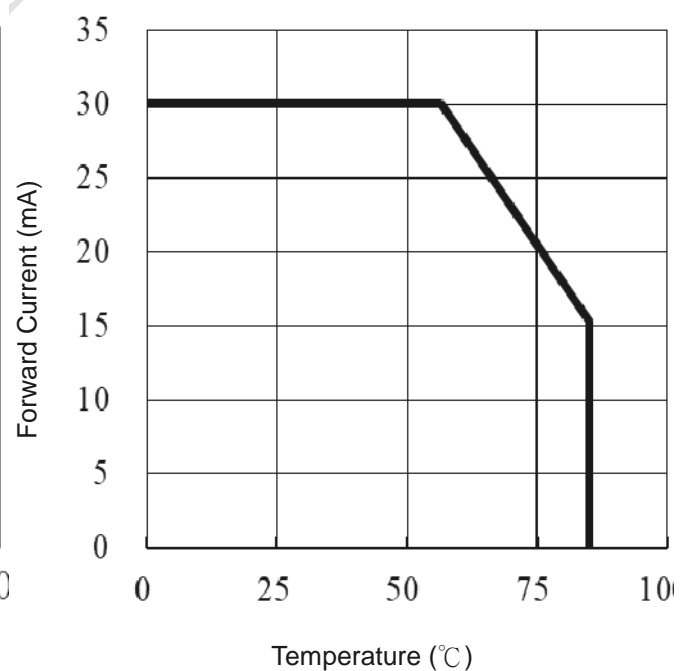

Forward Current vs. Forward Voltage (Ta=25°C)

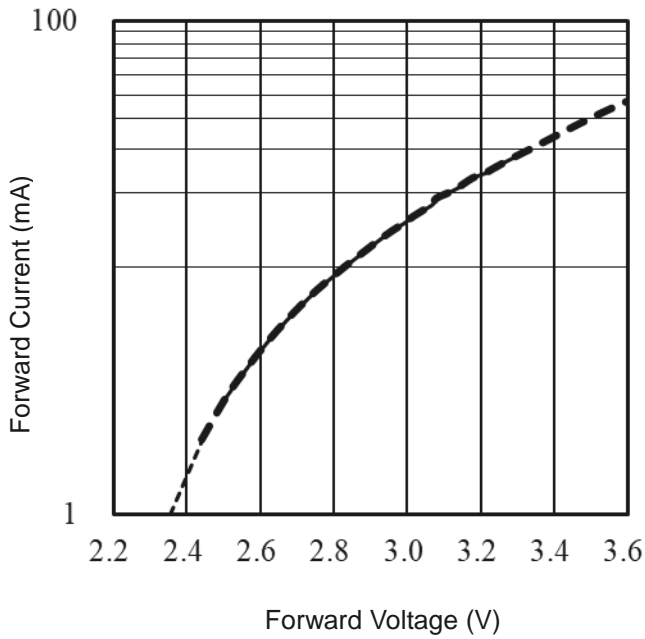

Dominant Wavelength vs. Forward Current (Ta=25°C)

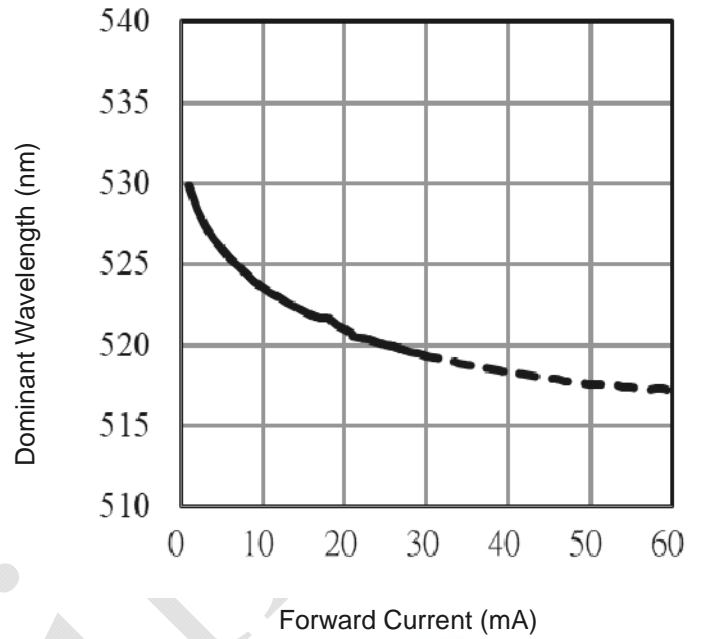

Relative Luminous Intensity vs. Forward Current (Ta=25°C)

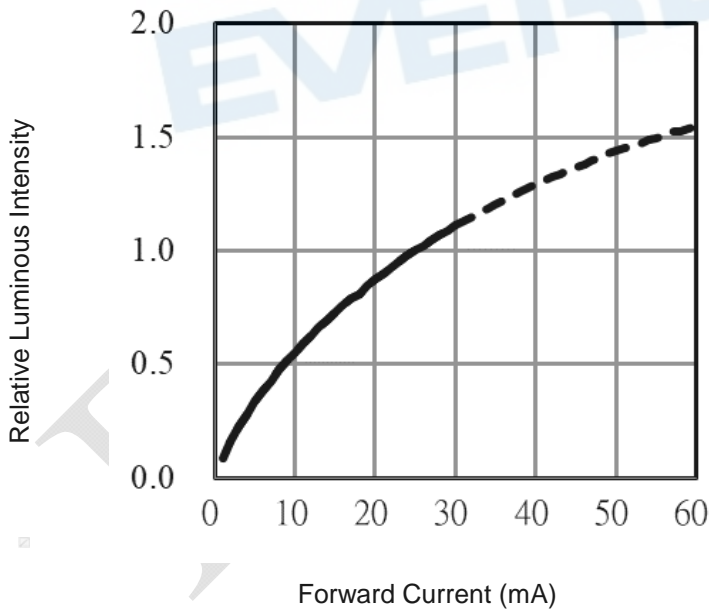

Max. Permissible Forwarded Current (Ta=25°C)

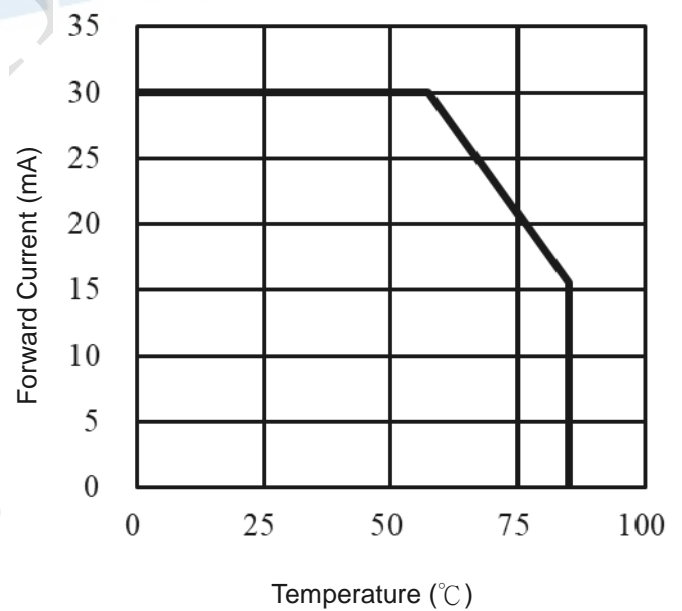



Forward Current vs. Forward Voltage (Ta=25°C)

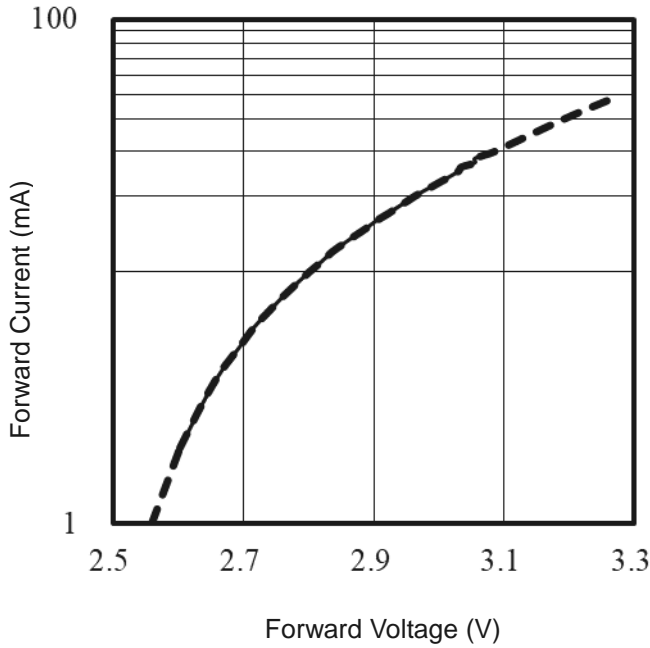

Dominant Wavelength vs. Forward Current (Ta=25°C)

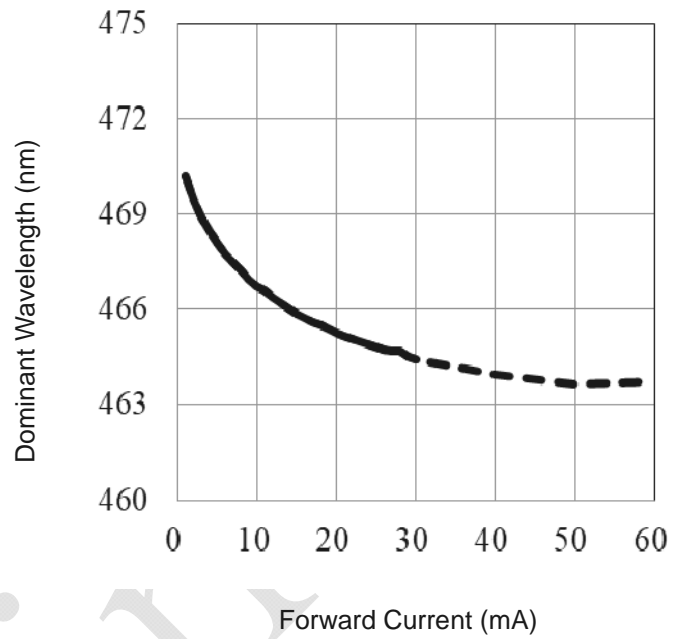

Relative Luminous Intensity vs. Forward Current (Ta=25°C)

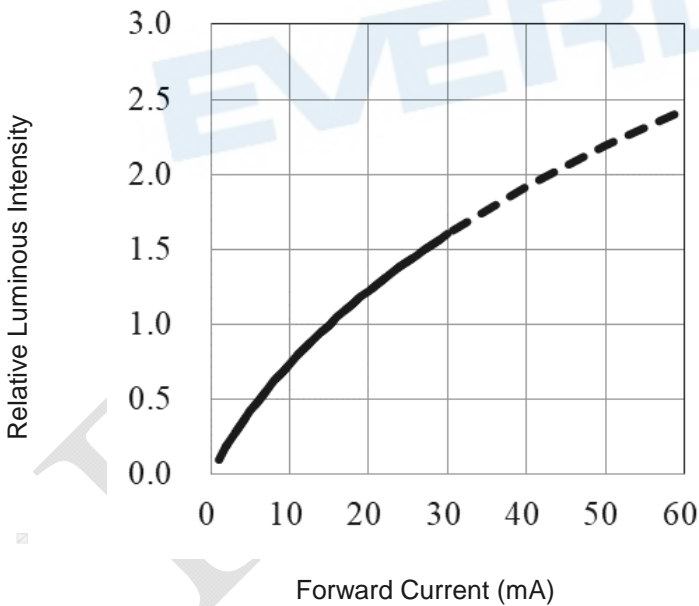

Max. Permissible Forwarded Current (Ta=25°C)

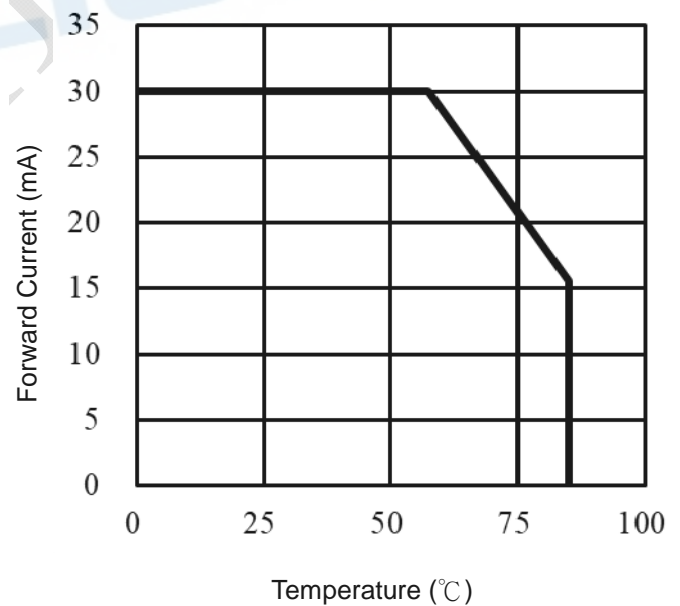

Moisture Resistant Packing Materials

Label Explanation



- CPN: Customer's Product Number
- P/N: Product Number
- QTY: Packing Quantity
- CAT: Luminous Intensity Rank
- HUE: Dom. Wavelength Rank
- REF: Forward Voltage Rank
- LOT No: Lot Number

Reel Dimensions

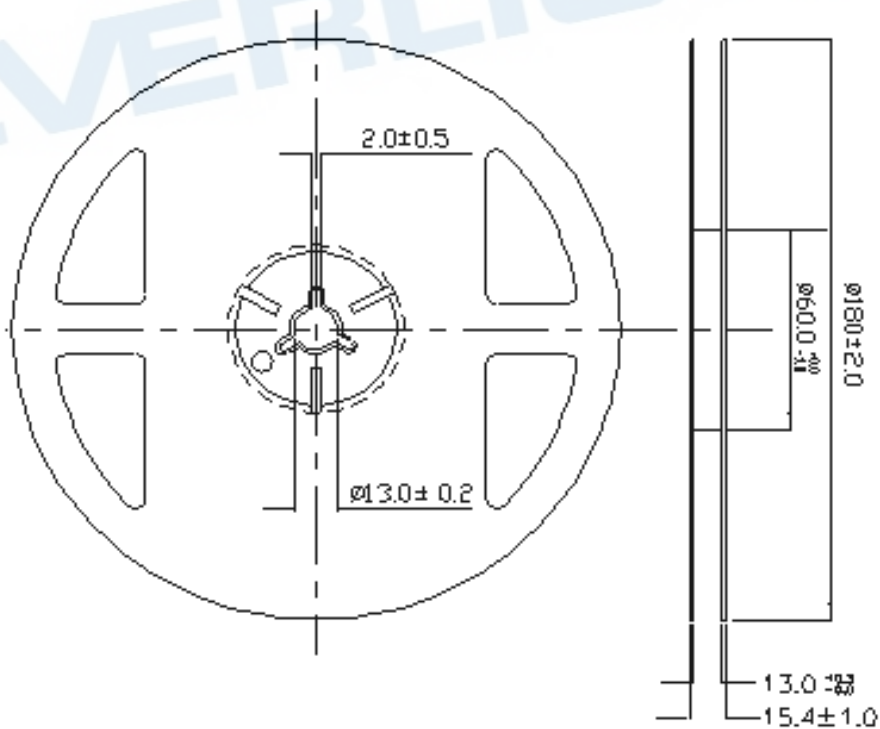

Carrier Tape Dimensions: Loaded Quantity 2000 pcs Per Reel

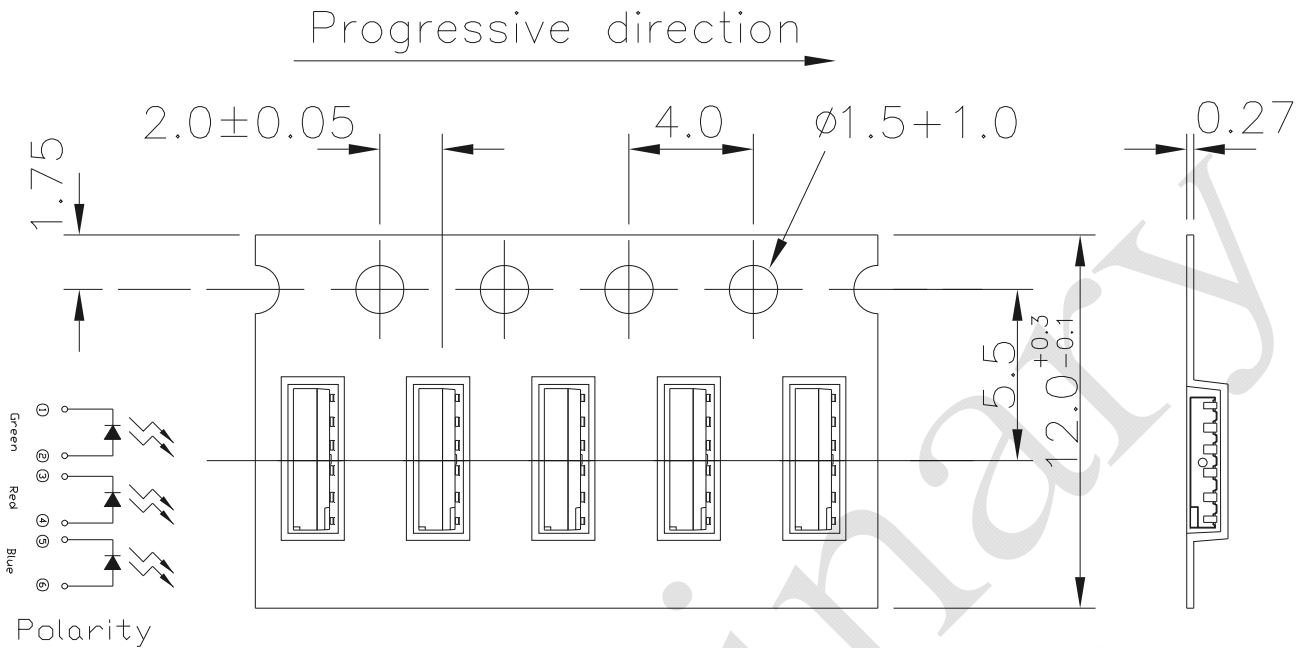

Notes:

1. Tolerances unless mentioned  $\pm 0.1$ mm. Unit = mm
2. Minimum packing amount is 250/500/1000/2000 pcs per reel

Moisture Resistant Packing Process

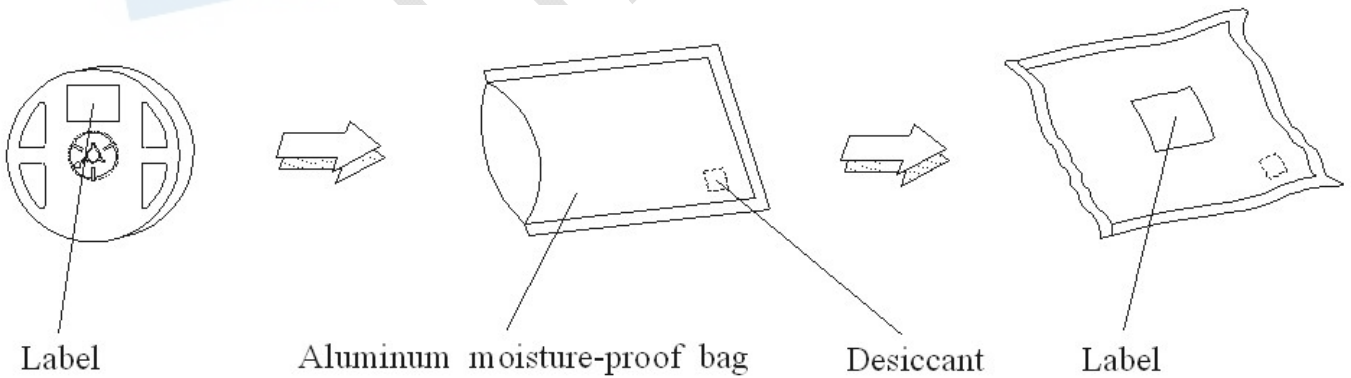

## Precautions for Use

### 1. Over-current-proof

1.1 Customer must apply resistors for protection, otherwise slight voltage shift will cause big current change ( Burn out will happen ).

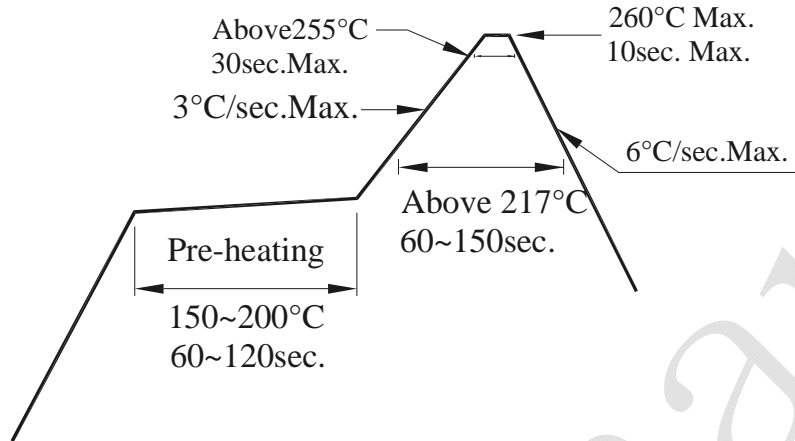

### 2. Storage

- 2.1 Moisture proof bag should only be opened immediately prior to usage.
- 2.2 Environment should be less than 30°C and 60% RH when moisture proof bag is opened.
- 2.3 After opening the package MSL Conditions stated on page 1 of this spec should not be exceeded.
- 2.4 If the moisture sensitivity card indicates higher than acceptable moisture, the component should be baked at min. 60deg +/-5deg for 24 hours.

### 3. Soldering Condition

- 3.1 Pb-free solder temperature profile
- 3.2 Reflow soldering should not be done more than two times.
- 3.3 When soldering, do not put stress on the LEDs during heating.
- 3.4 After soldering, do not warp the circuit board.

### 4. Soldering Iron

Each terminal is to go to the tip of soldering iron temperature less than 350°C for 3 seconds within once in less than the soldering iron capacity 25W. Leave two seconds and more intervals, and do soldering of each terminal. Be careful because the damage of the product is often started at the time of the hand solder.

### 5. Repairing

Repair should not be done after the LEDs have been soldered. When repairing is unavoidable, a double-head soldering iron should be used (as below figure). It should be confirmed beforehand whether the characteristics of the LEDs will or will not be damaged by repairing.

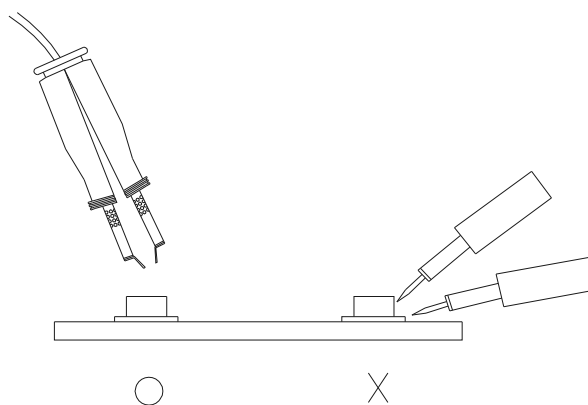

## Application Restrictions

High reliability applications such as military/aerospace, automotive safety/security systems, and medical equipment may require different product. If you have any concerns, please contact Everlight before using this product in your application. This specification guarantees the quality and performance of the product as an individual component. Do not use this product beyond the specification described in this document.

## DISCLAIMER

1. EVERLIGHT reserves the right(s) on the adjustment of product material mix for the specification.
2. The product meets EVERLIGHT published specification for a period of twelve (12) months from date of shipment.
3. The graphs shown in this datasheet are representing typical data only and do not show guaranteed values.
4. When using this product, please observe the absolute maximum ratings and the instructions for using outlined in these specification sheets. EVERLIGHT assumes no responsibility for any damage resulting from the use of the product which does not comply with the absolute maximum ratings and the instructions included in these specification sheets.
5. These specification sheets include materials protected under copyright of EVERLIGHT. Reproduction in any form is prohibited without obtaining EVERLIGHT's prior consent.
6. This product is not intended to be used for military, aircraft, automotive, medical, life sustaining or life saving applications or any other application which can result in human injury or death. Please contact authorized Everlight sales agent for special application request.