

TO-247-3L 1200V N-Channel Enhancement SiC Power MOSFET EL-MNR04120PA



V_{DSS}	=	1200	V
I_D	=	55	A
$R_{DS(on)}$	=	40	mΩ

Features

- High Blocking Voltage with Low On-Resistance
- Low gate resistance for high-frequency switching
- Low capacitances and low gate charge
- Best thermal conductivity and behavior
- Pb-Free Lead, Halogen Free, RoHS Compliant



Benefits

- Improve System Efficiency
- Increase Power Density
- Reduce Heat Sink Requirement
- Reduction of System Cost

Schematic

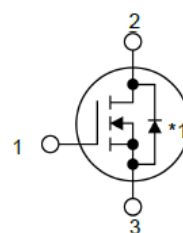

Pin Configuration

1. Gate
 2. Drain
 3. Source
- *1. Body Diode

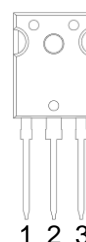

Applications

- Solar Inverters
- EV Battery Chargers
- High Voltage DC/DC Converters
- Switch Mode Power Supply

Key Performance Parameters

Symbol	V_{DSmin}	V_{GSS}	I_D	I_{DP}	$T_{J,max}$	P_D
Parameter	Drain-Source Voltage	Gate-Source Voltage (DC)	Continuous Drain Current	Pulse Drain Current	Junction temperature	Power Dissipation
Value	1200V	-4/18V	55A	171A	175 °C	454W

Maximum Ratings

Parameter	Symbol	Value	Unit	Test Conditions
Drain - Source Voltage	V_{DSmin}	1200	V	$V_{GS}= 0V, I_D= 250\mu A$
Gate - Source Voltage (DC) Max	V_{GS}	-10 / +20	V	
Gate - Source Voltage (DC)	V_{GS}	-4 / +18	V	Recommended operating values
Continuous Drain Current	I_D^{*2}	55	A	$V_{GS}=20V, T_C=25^\circ C$
		39		$V_{GS}=20V, T_C=100^\circ C$
Pulsed Drain Current	I_{DP}	171	A	
Power Dissipation	P_D^{*3}	454	W	
Operating Junction	T_J	175	$^\circ C$	
Storage Temperature	T_{stg}	-55 to +175	$^\circ C$	
Solder Temperature	T_L	260	$^\circ C$	
Mounting Torque	M_d	1 8.8	Nm lbf-in	M3 or 6-32 screw

*1 Please be advised not to use SiC-MOSFETs with V_{GS} below 12V as doing so may cause thermal runaway.

*2 Limited by maximum T_a and for Max. R_{thJC}

*3 $P_W \leq 10\mu s$, Duty cycle $\leq 1\%$

*4 Tested after applying V_{GS} for 100ms.

*5 Pulsed

Electrical Characteristics

Parameter	Symbol	Value			Unit	Test Conditions
		Min	Typ	Max		
Drain-Source Breakdown Voltage	$V_{(BR)DSS}$	1200	-	-	V	$V_{GS}=0V, I_D=250\mu A$
Gate Threshold Voltage	$V_{GS(th)}^{*4}$	-	2.8	-	V	$V_{GS}=V_{DS}, I_D=2mA$
Zero Gate Voltage Drain Current	I_{DSS}	-	1	-	μA	$V_{DS}=1200V, V_{GS}=0V$
Gate-Source Leakage Current	I_{GSS+}	-	10	200	nA	$V_{GS}=20V, V_{DS}=0V$
Drain-Source On-State Resistance	$R_{DS(on)}^{*5}$	-	40	60	m Ω	$V_{GS}=18V, I_D=24A$
		-	68	100		$V_{GS}=18V, I_D=24A, T_J=175^\circ C$
Input Capacitance	C_{iss}	-	2910	-	pF	$V_{GS}=0V$ $V_{DS}=800V$ $f=1MHz$
Output Capacitance	C_{oss}	-	103	-		
Reverse Transfer Capacitance	C_{rss}	-	10	-		
Turn-On Delay Time	$t_{d(on)}$	-	50	-	ns	$V_{DS}=800V$ $I_D=24A$ $V_{GS}=-4V/+18V$ $R_G=2.5\Omega$
Rise Time	t_r	-	20	-		
Turn-Off Delay Time	$t_{d(off)}$	-	45	-		
Fall Time	t_f	-	10	-		
Gate to Source Charge	Q_{gs}	-	40	-	nC	$V_{DS}=800V$ $I_{DSS}=24A$ $V_{GS}=+18V/-4V$
Gate to Drain Charge	Q_{gd}	-	29	-		
Total Gate Charge	Q_g	-	115	-		
Gate resistance	R_G	-	1	-	Ω	$f=1MHz, V_{AC}=25mV$

Body Diode Characteristics

Parameter	Symbol	Value		Unit	Test Conditions
		Typ.	Max.		
Diode Forward Voltage	V_{SD}	4.6	-	V	$V_{GS} = -4V, I_S = 24A$
Continuous Diode Forward Current	I_S	-	40	A	

Thermal Characteristics (Measured conformable to JESD51-14.)

Parameter	Symbol	Value		Unit
		Typ	Max	
Thermal Resistance from Junction to Case	$R_{\theta JC}$	0.26	0.33	$^{\circ}C/W$

Typical Performance

Typical Output Characteristics (I)

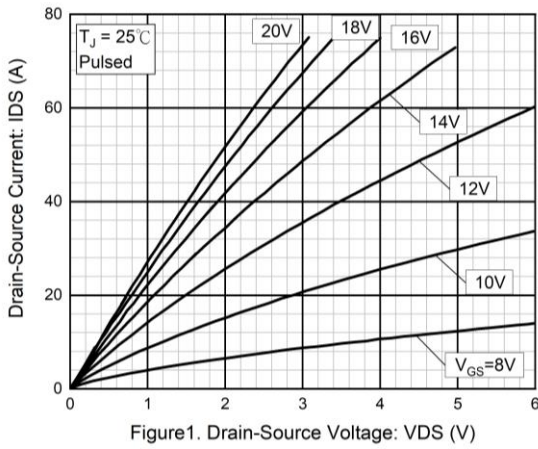

Typical Output Characteristics(II)

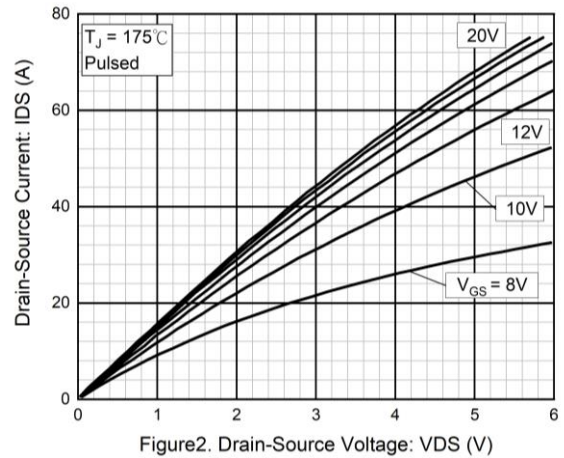

Typical on-resistance by various junction temperature and gate voltage

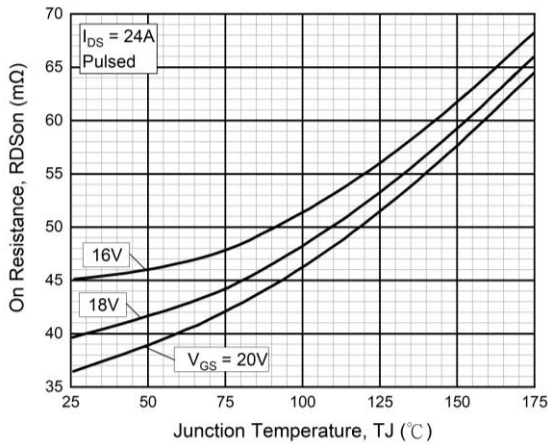

Normalized on-resistance by various junction temperature

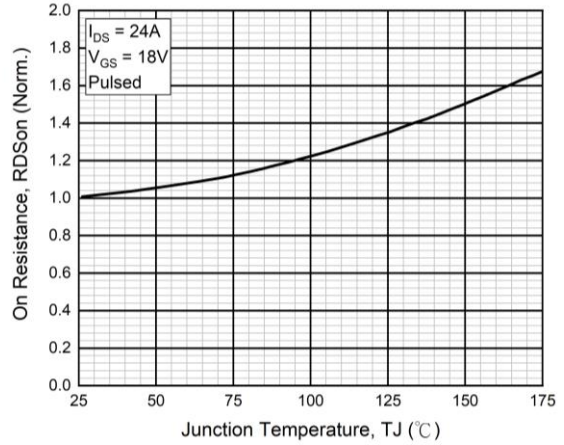

Typical on-resistance by various drain current and junction temperature

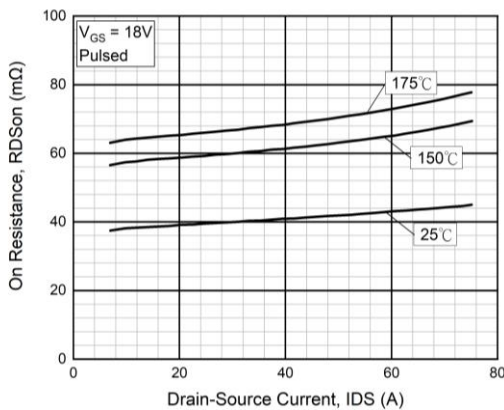

Typical transfer characteristics by various gate voltage and junction temperature

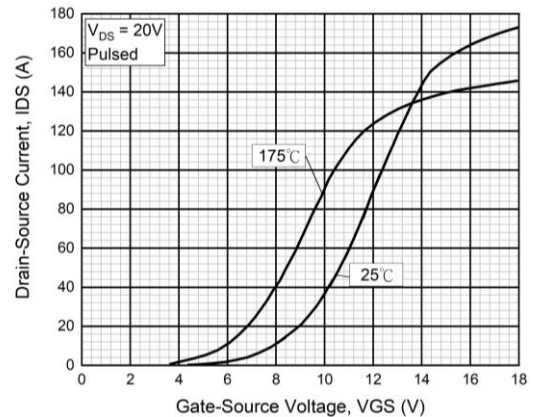

Typical threshold voltage by various junction temperature

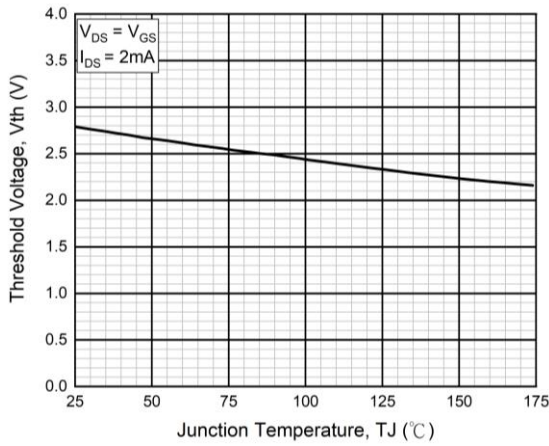

Normalized breakdown voltage by various junction temperature

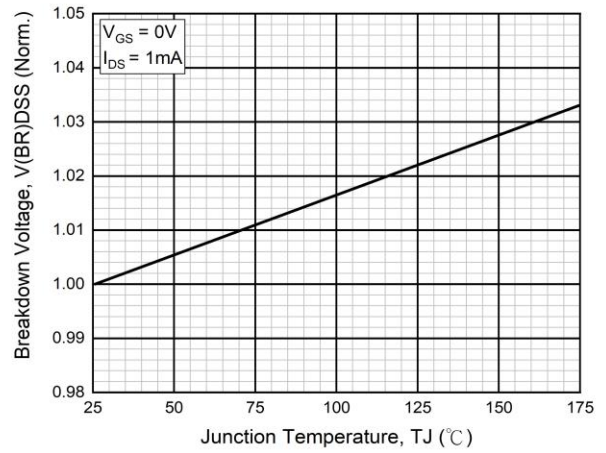

Typical body diode forward current by various forward voltage and gate voltage(I)

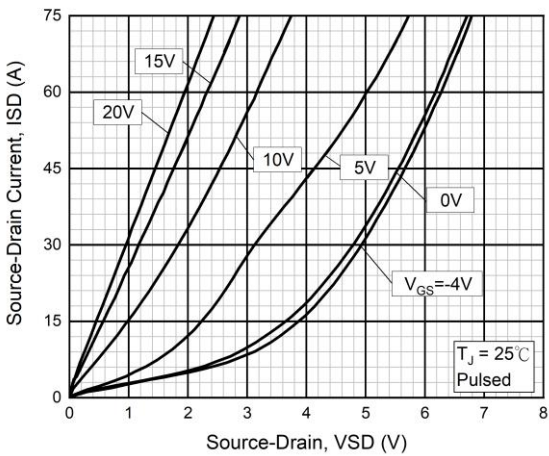

Typical body diode forward current by various forward voltage and gate voltage(II)

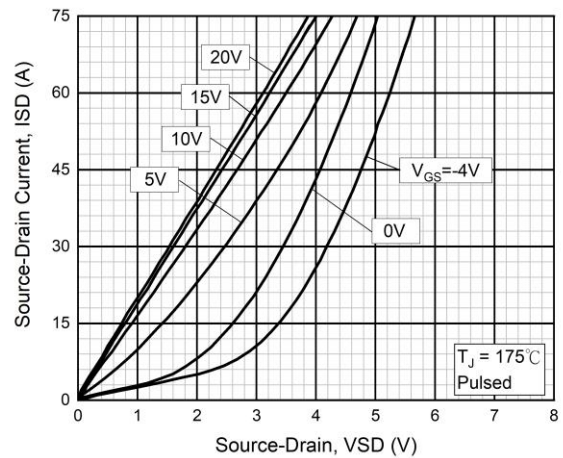

Typical body diode forward voltage by various junction temperature

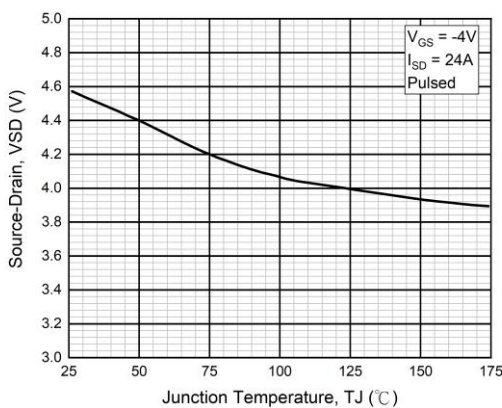

Typical body diode forward voltage by various gate voltage and junction temperature

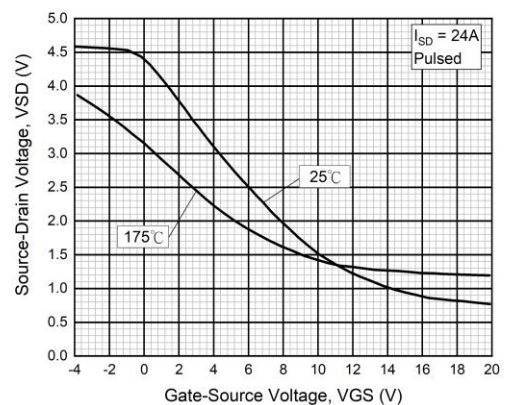

Typical capacitance by various drain voltage

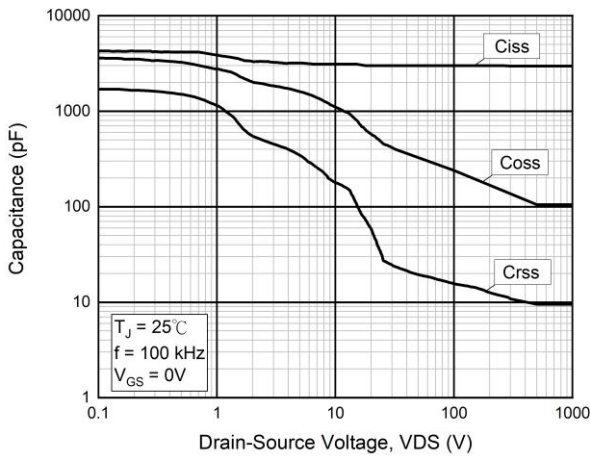

Typical gate charge characteristic

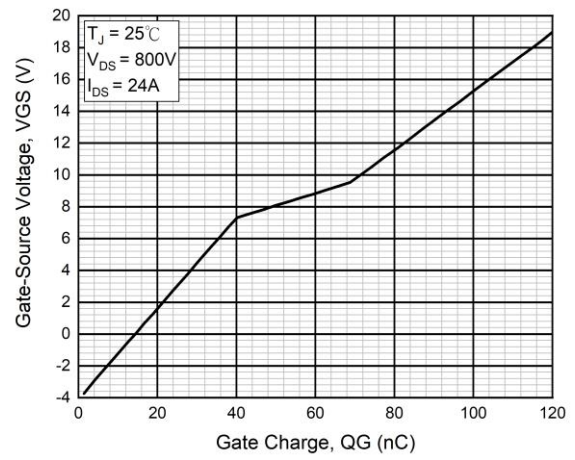

Maximum Safe Operating Area (SOA)

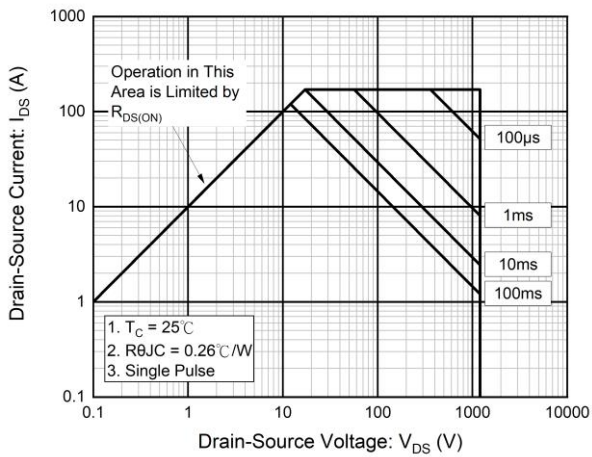

Power dissipation vs. Junction Temperature

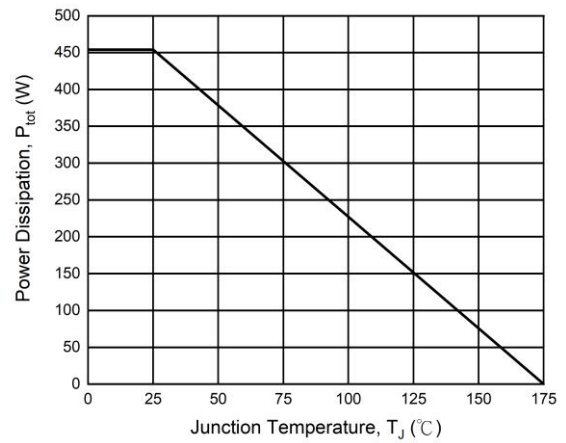

Package Outlines

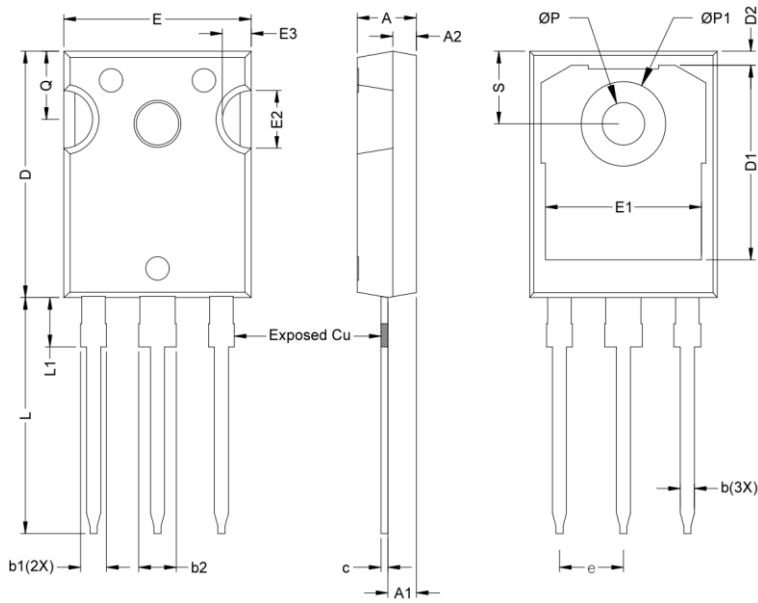

DIM	MILLIMETERS		
	MIN	TYP.	MAX
A	4.82	5.02	5.22
A1	2.21	2.41	2.61
A2	1.8	2	2.2
b	0.95	1.2	1.45
b1	1.95	2.2	2.45
b2	2.95	3.2	3.45
c	0.35	0.6	0.85
D	20.75	20.95	21.15
D1	16.3	16.55	16.8
D2	0.99	1.19	1.39
E	15.74	15.94	16.14
E1	13.01	13.26	13.51
E2	4.71	4.91	5.11
E3	2.26	2.46	2.66
e	5.44 B S C.		
L	19.82	20.07	20.32
L1	3.94	4.19	4.44
P	3.41	3.61	3.81
P1	6.94	7.19	7.44
Q	5.59	5.79	5.99
S	5.97	6.17	6.37

Unit : mm

Drawing and Dimensions

Recommended pad layout for surface mount leadform

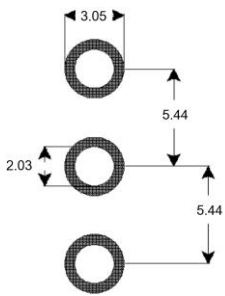

Unit : mm

DISCLAIMER

1. Above specification may be changed without notice. EVERLIGHT will reserve authority on material change for above specification.
2. The graphs shown in this datasheet are representing typical data only and do not show guaranteed values.
3. When using this product, please observe the absolute maximum ratings and the instructions for use outlined in these specification sheets. EVERLIGHT assumes no responsibility for any damage resulting from use of the product which does not comply with the absolute maximum ratings and the instructions included in these specification sheets.
4. These specification sheets include materials protected under copyright of EVERLIGHT. Reproduction in any form is prohibited without the specific consent of EVERLIGHT.
5. This product is not intended to be used for military, aircraft, automotive, medical, life sustaining or life saving applications or any other application which can result in human injury or death. Please contact authorized Everlight sales agent for special application request.
6. Statements regarding the suitability of products for certain types of applications are based on Everlight's knowledge of typical requirements that are often placed on Everlight products in generic applications. Such statements are not binding statements about the suitability of products for a particular application. It is the customer's responsibility to validate that a particular product with the properties described in the product specification is suitable for use in a particular application. Parameters provided in datasheets and/or specifications may vary in different applications and performance may vary over time. All operating parameters, including typical parameters, must be validated for each customer application by the customer's technical experts. Product specifications do not expand or otherwise modify Everlight's terms and conditions of purchase, including but not limited to the warranty expressed therein.