

TO-220-2L SiC SBD EL-SF01065JA 650V SiC Schottky Diode Series

Preliminary

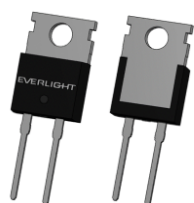

V_{RRM}	=	650	V
Q_c	=	23	nC
$I_F(T_C=135^\circ\text{C})$	=	10	A
V_F	=	1.35	V

Features

- Low Forward Voltage
- Ultra-Fast Switching
- Zero Reverse Recovery Current
- High-Frequency Operation and increased power density
- High Surge Current Capability
- Pb-free Lead, Halogen Free, ROHS Compliant



Benefits

- Improve System Efficiency
- Reduction of Heat Sink Requirement
- Essentially No Switching Losses
- Parallel Devices Without Thermal Runaway

Applications

- Solar inverter/Motor Drivers/Data Center
- Boost Diodes in PFC or DC/DC Stages
- AC/DC Converters

Schematic

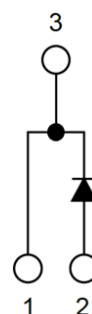

Pin Configuration

1. Cathode
2. Anode

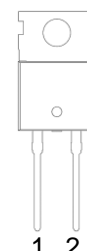

Key Performance Parameters

Symbol	V_{RRM}	I_F	I_{FSM}	Q_c	$T_{J,max}$
Value	650V	10A	90A	23nC	175°C
Condition	$T_C@25^\circ\text{C}$	$T_C@135^\circ\text{C}$	$t_p=10\text{ms}$ $T_C@25^\circ\text{C}$ Sine half wave	$V_R=400\text{V}, T_j=25^\circ\text{C}$ $Q_c = \int_0^{V_R} I_C(V)dV$	

Maximum Ratings (T_a=25°C, unless specified otherwise)

Parameter	Symbol	Value	Unit	Test condition
Repetitive Peak Reverse Voltage	V _{RRM}	650	V	T _C = 25°C
Surge Peak Reverse Voltage	V _{RSM}	650	V	T _C = 25°C
DC Blocking Voltage	V _R	650	V	T _C = 25°C
Continuous Forward Current	I _F *1	10	A	T _C = 135°C
Non-Repetitive Forward Surge Current	I _{FSM}	90	A	T _C = 25°C, t _p = 10ms Sine half wave
Operating Junction and Storage Temperature	T _J , T _{STG}	-55 to +175	°C	
TO-220 Mounting Torque M3 Screw	T _{orq}	1 8.8	Nm lbf-in	

*1 Limited by maximum T_A and for Max. R_{thJC}.

Thermal Characteristics (Measured conformable to JESD51-14.)

Parameter	Symbol	Values	Unit
Thermal Resistance from Junction to Case	R _{θJC}	1.3	°C/W

Electrical Characteristics (T_a=25°C, unless specified otherwise)

Parameter	Symbol	Values			Unit	Test condition
		Min.	Typ.	Max.		
DC blocking voltage	V _{DC}	650	-	-	V	T _J = 25°C, I _R = 2.0mA
Forward Voltage	V _F	-	1.35	1.50	V	I _F = 10A, T _J = 25°C
			1.50	-		I _F = 10A, T _J = 150°C
			1.60	-		I _F = 10A, T _J = 175°C
Reverse Current	I _R	-	1	50	μA	V _R = 650V, T _J = 25°C
			20	-		V _R = 650V, T _J = 150°C
			50	-		V _R = 650V, T _J = 175°C
Total Capacitance	C	-	390	-	pF	V _R = 1V, f= 1MHz T _J = 25°C
			38			V _R = 650V, f= 1MHz T _J = 25°C
Total Capacitive Charge	Q _C	-	23	-	nC	V _R = 400V, T _J = 25°C Q _C = ∫ ₀ ^{V_R} C(V)dV

Typical Performance ($T_a=25^\circ\text{C}$, unless specified otherwise)

V_F - I_F Characteristics

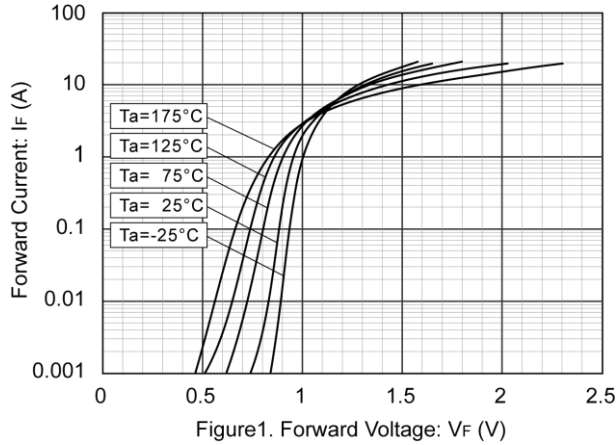

V_F - I_F Characteristics

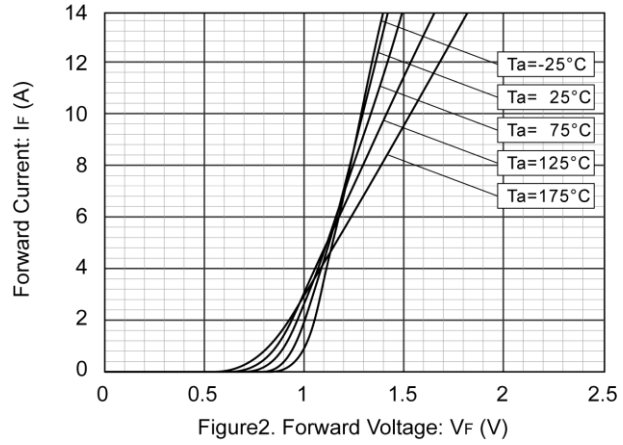

V_R - I_R Characteristics

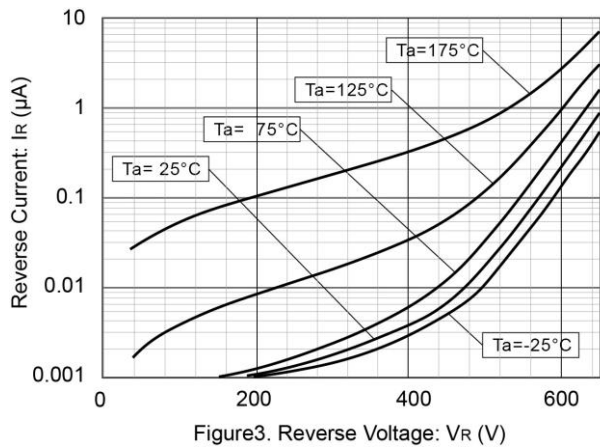

V_R - C_t Characteristics

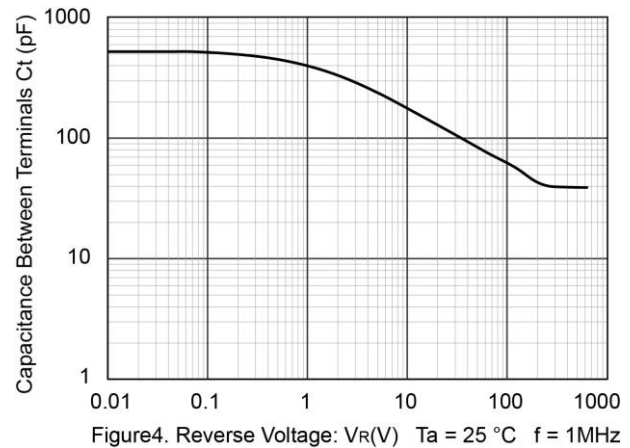

Maximum I_P - T_C Characteristics

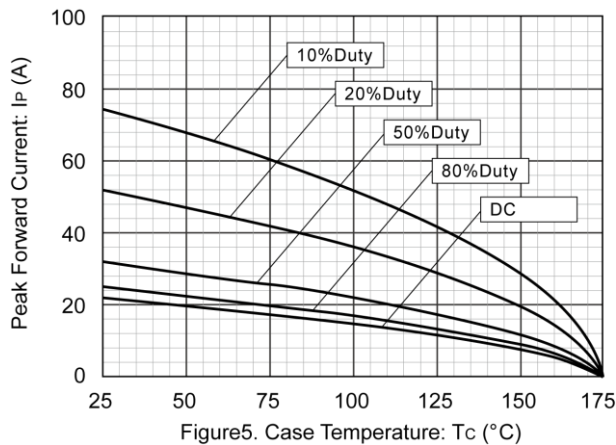

Power Dissipation

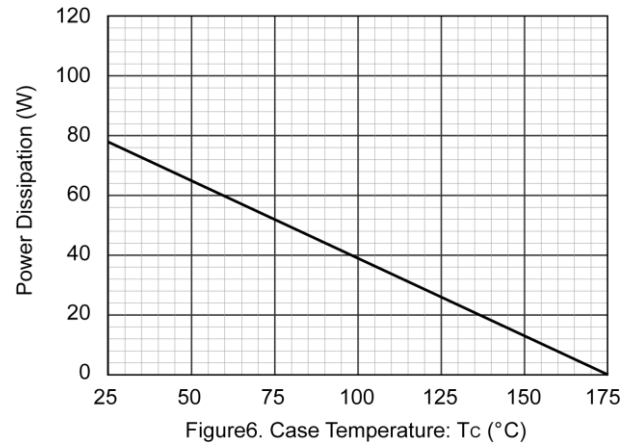

I_{FSM} - P_W Characteristics

E_C - V_R Characteristics

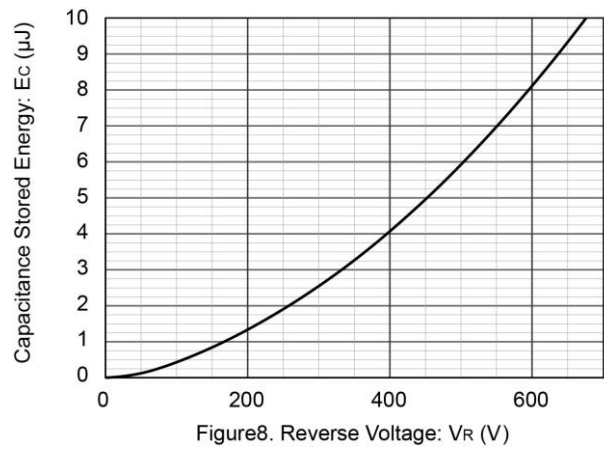
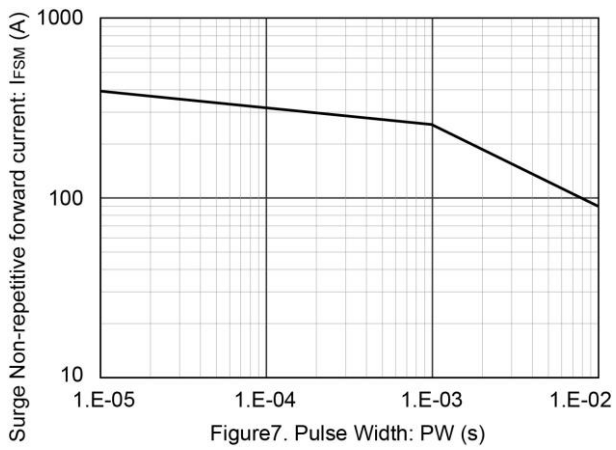

Package Outlines

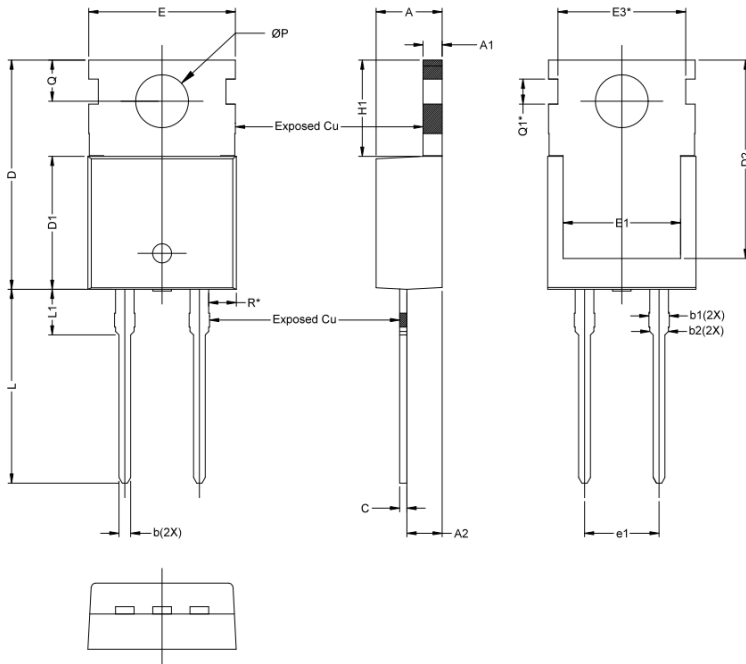

D I M	M I L L I M E		
	M I N	T Y P	M A X
A	4.3	4.5	4.7
A1	1.05	1.3	1.55
A2	2.2	2.4	2.6
b	0.7	0.8	0.9
b1	1.14	1.39	1.64
b2	1.02	1.27	1.52
C	0.4	0.5	0.6
D	15.4	15.6	15.8
D1	8.85	9.05	9.25
D2	13.25	13.5	13.75
E	9.74	9.99	10.24
E1	7.75	8	8.25
E3*	8 . 7 0 R E F		
e1	5 . 0 8 B S C		
H1	6.35	6.55	6.75
L	12.93	13.18	13.43
L1	2.85	3.1	3.35
P	3.35	3.6	3.85
Q	2.55	2.8	3.05
Q1*	1 . 7 0 R E F		
R*	1 . 8 8 R E F		

Unit : mm

Drawing and Dimensions

Recommended pad layout for surface mount leadform

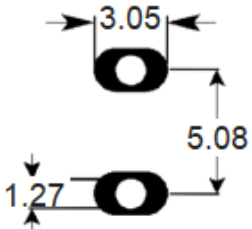

Unit : mm

DISCLAIMER

1. Above specification may be changed without notice. EVERLIGHT will reserve authority on material change for above specification.
2. The graphs shown in this datasheet are representing typical data only and do not show guaranteed values.
3. When using this product, please observe the absolute maximum ratings and the instructions for use outlined in these specification sheets. EVERLIGHT assumes no responsibility for any damage resulting from use of the product which does not comply with the absolute maximum ratings and the instructions included in these specification sheets.
4. These specification sheets include materials protected under copyright of EVERLIGHT. Reproduction in any form is prohibited without the specific consent of EVERLIGHT.
5. This product is not intended to be used for military, aircraft, automotive, medical, life sustaining or life saving applications or any other application which can result in human injury or death. Please contact authorized Everlight sales agent for special application request.
6. Statements regarding the suitability of products for certain types of applications are based on Everlight's knowledge of typical requirements that are often placed on Everlight products in generic applications. Such statements are not binding statements about the suitability of products for a particular application. It is the customer's responsibility to validate that a particular product with the properties described in the product specification is suitable for use in a particular application. Parameters provided in datasheets and/or specifications may vary in different applications and performance may vary over time. All operating parameters, including typical parameters, must be validated for each customer application by the customer's technical experts. Product specifications do not expand or otherwise modify Everlight's terms and conditions of purchase, including but not limited to the warranty expressed therein.